

Power contactor, AC-3 16 A, 7.5 kW / 400 V 1 NO, 24 V DC 3-pole,
Size S00 screw terminals



Product brand name	SIRIUS
Product designation	Power contactor
Product type designation	3RT2

General technical data	
Size of contactor	S00
Product extension	
<ul style="list-style-type: none"> function module for communication 	No
<ul style="list-style-type: none"> Auxiliary switch 	Yes
Power loss [W] for rated value of the current	
<ul style="list-style-type: none"> at AC in hot operating state 	6.6 W
<ul style="list-style-type: none"> at AC in hot operating state per pole 	2.2 W
Power loss [W] for rated value of the current without load current share typical	4 W
Surge voltage resistance	
<ul style="list-style-type: none"> of main circuit rated value 	6 kV
<ul style="list-style-type: none"> of auxiliary circuit rated value 	6 kV
maximum permissible voltage for safe isolation	
<ul style="list-style-type: none"> between coil and main contacts acc. to EN 60947-1 	400 V

Protection class IP	
<ul style="list-style-type: none"> • on the front • of the terminal 	IP20 IP20
Shock resistance at rectangular impulse	
<ul style="list-style-type: none"> • at DC 	7.3g / 5 ms, 4.7g / 10 ms
Shock resistance with sine pulse	
<ul style="list-style-type: none"> • at DC 	11,4g / 5 ms, 7,3g / 10 ms
Mechanical service life (switching cycles)	
<ul style="list-style-type: none"> • of contactor typical • of the contactor with added electronics-compatible auxiliary switch block typical • of the contactor with added auxiliary switch block typical 	30 000 000 5 000 000 10 000 000
Reference code acc. to DIN 40719 extended according to IEC 204-2 acc. to IEC 750	K
Reference code acc. to DIN EN 81346-2	Q

Ambient conditions

Installation altitude at height above sea level	
<ul style="list-style-type: none"> • maximum 	2 000 m
Ambient temperature	
<ul style="list-style-type: none"> • during operation • during storage 	-25 ... +60 °C -55 ... +80 °C

Main circuit

Number of poles for main current circuit	3
Number of NO contacts for main contacts	3
Operating voltage	
<ul style="list-style-type: none"> • at AC-3 rated value maximum 	690 V
Operating current	
<ul style="list-style-type: none"> • at AC-1 at 400 V <ul style="list-style-type: none"> — at ambient temperature 40 °C rated value • at AC-1 <ul style="list-style-type: none"> — up to 690 V at ambient temperature 40 °C rated value — up to 690 V at ambient temperature 60 °C rated value • at AC-2 at 400 V rated value • at AC-3 <ul style="list-style-type: none"> — at 400 V rated value — at 500 V rated value — at 690 V rated value • at AC-4 at 400 V rated value • at AC-5a up to 690 V rated value 	22 A 22 A 20 A 16 A 16 A 12.4 A 8.9 A 11.5 A 19.4 A

<ul style="list-style-type: none"> • at AC-5b up to 400 V rated value 	13.2 A
<ul style="list-style-type: none"> • at AC-6a <ul style="list-style-type: none"> — up to 230 V for current peak value n=20 rated value — up to 400 V for current peak value n=20 rated value — up to 500 V for current peak value n=20 rated value — up to 690 V for current peak value n=20 rated value 	9.6 A 9.6 A 9.6 A 8.9 A
<ul style="list-style-type: none"> • at AC-6a <ul style="list-style-type: none"> — up to 230 V for current peak value n=30 rated value — up to 400 V for current peak value n=30 rated value — up to 500 V for current peak value n=30 rated value — up to 690 V for current peak value n=30 rated value 	6.6 A 6.4 A 6.4 A 6.4 A
Minimum cross-section in main circuit	
<ul style="list-style-type: none"> • at maximum AC-1 rated value 	4 mm ²
Operating current for approx. 200000 operating cycles at AC-4	
<ul style="list-style-type: none"> • at 400 V rated value • at 690 V rated value 	5.5 A 4.4 A
Operating current	
<ul style="list-style-type: none"> • at 1 current path at DC-1 <ul style="list-style-type: none"> — at 24 V rated value — at 110 V rated value — at 220 V rated value — at 440 V rated value — at 600 V rated value • with 2 current paths in series at DC-1 <ul style="list-style-type: none"> — at 24 V rated value — at 110 V rated value — at 220 V rated value — at 440 V rated value — at 600 V rated value • with 3 current paths in series at DC-1 <ul style="list-style-type: none"> — at 24 V rated value — at 110 V rated value — at 220 V rated value — at 440 V rated value 	20 A 2.1 A 0.8 A 0.6 A 0.6 A 20 A 12 A 1.6 A 0.8 A 0.7 A 20 A 20 A 20 A 1.3 A

— at 600 V rated value	1 A
Operating current	
• at 1 current path at DC-3 at DC-5	
— at 24 V rated value	20 A
— at 110 V rated value	0.1 A
• with 2 current paths in series at DC-3 at DC-5	
— at 24 V rated value	20 A
— at 110 V rated value	0.35 A
• with 3 current paths in series at DC-3 at DC-5	
— at 24 V rated value	20 A
— at 110 V rated value	20 A
— at 220 V rated value	1.5 A
— at 440 V rated value	0.2 A
— at 600 V rated value	0.2 A
Operating power	
• at AC-1	
— at 230 V rated value	7.5 kW
— at 230 V at 60 °C rated value	7.5 kW
— at 400 V rated value	13 kW
— at 400 V at 60 °C rated value	13 kW
— at 690 V rated value	22 kW
— at 690 V at 60 °C rated value	22 kW
• at AC-2 at 400 V rated value	7.5 kW
• at AC-3	
— at 230 V rated value	4 kW
— at 400 V rated value	7.5 kW
— at 500 V rated value	7.5 kW
— at 690 V rated value	7.5 kW
Operating power for approx. 200000 operating cycles at AC-4	
• at 400 V rated value	2.5 kW
• at 690 V rated value	3.5 kW
No-load switching frequency	
• at DC	10 000 1/h
Operating frequency	
• at AC-1 maximum	1 000 1/h
• at AC-2 maximum	750 1/h
• at AC-3 maximum	750 1/h
• at AC-4 maximum	250 1/h
Control circuit/ Control	
Type of voltage of the control supply voltage	DC

Control supply voltage at DC	
• rated value	24 V
Operating range factor control supply voltage rated value of magnet coil at DC	
• initial value	0.8
• Full-scale value	1.1
Closing power of magnet coil at DC	4 W
Holding power of magnet coil at DC	4 W
Closing delay	
• at DC	30 ... 100 ms
Opening delay	
• at DC	7 ... 13 ms
Arcing time	10 ... 15 ms
Control version of the switch operating mechanism	Standard A1 - A2

Auxiliary circuit

Number of NO contacts for auxiliary contacts	
• instantaneous contact	1
Operating current at AC-12 maximum	10 A
Operating current at AC-15	
• at 230 V rated value	10 A
• at 400 V rated value	3 A
• at 500 V rated value	2 A
• at 690 V rated value	1 A
Operating current at DC-12	
• at 24 V rated value	10 A
• at 48 V rated value	6 A
• at 60 V rated value	6 A
• at 110 V rated value	3 A
• at 125 V rated value	2 A
• at 220 V rated value	1 A
• at 600 V rated value	0.15 A
Operating current at DC-13	
• at 24 V rated value	10 A
• at 48 V rated value	2 A
• at 60 V rated value	2 A
• at 110 V rated value	1 A
• at 125 V rated value	0.9 A
• at 220 V rated value	0.3 A
• at 600 V rated value	0.1 A
Contact reliability of auxiliary contacts	1 faulty switching per 100 million (17 V, 1 mA)

UL/CSA ratings

Full-load current (FLA) for three-phase AC motor	
<ul style="list-style-type: none"> • at 480 V rated value • at 600 V rated value 	<p>14 A</p> <p>11 A</p>
Yielded mechanical performance [hp]	
<ul style="list-style-type: none"> • for single-phase AC motor <ul style="list-style-type: none"> — at 110/120 V rated value — at 230 V rated value • for three-phase AC motor <ul style="list-style-type: none"> — at 200/208 V rated value — at 220/230 V rated value — at 460/480 V rated value — at 575/600 V rated value 	<p>1 hp</p> <p>2 hp</p> <p>3 hp</p> <p>5 hp</p> <p>10 hp</p> <p>10 hp</p>
Contact rating of auxiliary contacts according to UL	A600 / Q600

Short-circuit protection

Design of the fuse link	
<ul style="list-style-type: none"> • for short-circuit protection of the main circuit <ul style="list-style-type: none"> — with type of coordination 1 required — with type of assignment 2 required • for short-circuit protection of the auxiliary switch required 	<p>gG: 50A (690V,100kA), aM: 25A (690V,100kA), BS88: 50A (415V,80kA)</p> <p>gG: 25A (690V,100kA), aM: 20A (690V,100kA), BS88: 25A (415V,80kA)</p> <p>gG: 10 A (500 V, 1 kA)</p>

Installation/ mounting/ dimensions

Mounting position	+/-180° rotation possible on vertical mounting surface; can be tilted forward and backward by +/- 22.5° on vertical mounting surface
Mounting type	screw and snap-on mounting onto 35 mm standard mounting rail according to DIN EN 60715
<ul style="list-style-type: none"> • Side-by-side mounting 	Yes
Height	58 mm
Width	45 mm
Depth	73 mm
Required spacing	
<ul style="list-style-type: none"> • with side-by-side mounting <ul style="list-style-type: none"> — forwards — upwards — downwards — at the side • for grounded parts <ul style="list-style-type: none"> — forwards — upwards — at the side 	<p>10 mm</p> <p>10 mm</p> <p>10 mm</p> <p>0 mm</p> <p>10 mm</p> <p>10 mm</p> <p>6 mm</p>

— downwards	10 mm
• for live parts	
— forwards	10 mm
— upwards	10 mm
— downwards	10 mm
— at the side	6 mm

Connections/ Terminals





Type of electrical connection	
• for main current circuit	screw-type terminals
• for auxiliary and control current circuit	screw-type terminals
• at contactor for auxiliary contacts	Screw-type terminals
• of magnet coil	Screw-type terminals
Type of connectable conductor cross-sections	
• for main contacts	
— solid	2x (0.5 ... 1.5 mm ²), 2x (0.75 ... 2.5 mm ²), 2x 4 mm ²
— single or multi-stranded	2x (0,5 ... 1,5 mm ²), 2x (0,75 ... 2,5 mm ²), 2x 4 mm ²
— finely stranded with core end processing	2x (0.5 ... 1.5 mm ²), 2x (0.75 ... 2.5 mm ²)
• at AWG conductors for main contacts	2x (20 ... 16), 2x (18 ... 14), 2x 12
Connectable conductor cross-section for main contacts	
• solid	0.5 ... 4 mm ²
• stranded	0.5 ... 4 mm ²
• finely stranded with core end processing	0.5 ... 2.5 mm ²
Connectable conductor cross-section for auxiliary contacts	
• single or multi-stranded	0.5 ... 4 mm ²
• finely stranded with core end processing	0.5 ... 2.5 mm ²
Type of connectable conductor cross-sections	
• for auxiliary contacts	
— single or multi-stranded	2x (0,5 ... 1,5 mm ²), 2x (0,75 ... 2,5 mm ²), 2x 4 mm ²
— finely stranded with core end processing	2x (0.5 ... 1.5 mm ²), 2x (0.75 ... 2.5 mm ²)
• at AWG conductors for auxiliary contacts	2x (20 ... 16), 2x (18 ... 14), 2x 12
AWG number as coded connectable conductor cross section	
• for main contacts	20 ... 12
• for auxiliary contacts	20 ... 12

Safety related data





B10 value	
• with high demand rate acc. to SN 31920	1 000 000
Proportion of dangerous failures	
• with low demand rate acc. to SN 31920	40 %

• with high demand rate acc. to SN 31920	73 %
Failure rate [FIT]	
• with low demand rate acc. to SN 31920	100 FIT
Product function	
• Mirror contact acc. to IEC 60947-4-1	Yes; with 3RH29
T1 value for proof test interval or service life acc. to IEC 61508	20 y
Protection against electrical shock	finger-safe

Certificates/ approvals

General Product Approval					EMC
			KC		
CCC	CSA	UL			RCM

Functional Safety/Safety of Machinery	Declaration of Conformity	Test Certificates			
Type Examination Certificate	 EG-Konf.	Miscellaneous	Type Test Certificates/Test Report	Special Test Certificate	Miscellaneous

Marine / Shipping					
					
ABS	BUREAU VERITAS	LRS	PRS	RINA	RMRS

Marine / Shipping	other
	Confirmation  VDE

Further information

- Information- and Downloadcenter (Catalogs, Brochures,...)**
www.siemens.com/sirius/catalogs
- Industry Mall (Online ordering system)**
<https://mall.industry.siemens.com/mall/en/en/Catalog/product?mlfb=3RT2018-1BB41>
- Cax online generator**
<http://support.automation.siemens.com/WW/CAXorder/default.aspx?lang=en&mlfb=3RT2018-1BB41>

Service&Support (Manuals, Certificates, Characteristics, FAQs,...)

<https://support.industry.siemens.com/cs/ww/en/ps/3RT2018-1BB41>

Image database (product images, 2D dimension drawings, 3D models, device circuit diagrams, EPLAN macros, ...)

http://www.automation.siemens.com/bilddb/cax_de.aspx?mlfb=3RT2018-1BB41&lang=en

Characteristic: Tripping characteristics, I²t, Let-through current

<https://support.industry.siemens.com/cs/ww/en/ps/3RT2018-1BB41/char>

Further characteristics (e.g. electrical endurance, switching frequency)

<http://www.automation.siemens.com/bilddb/index.aspx?view=Search&mlfb=3RT2018-1BB41&objecttype=14&gridview=view1>

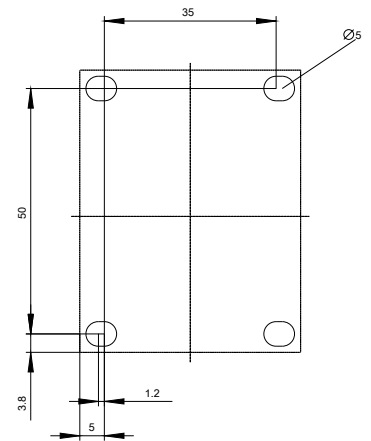
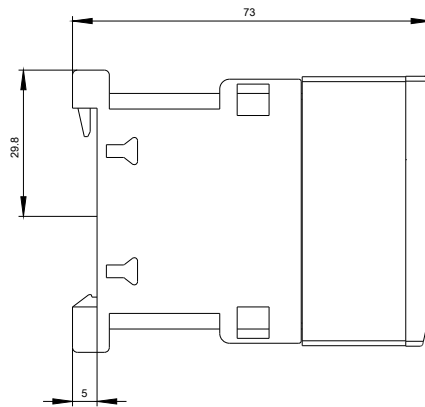
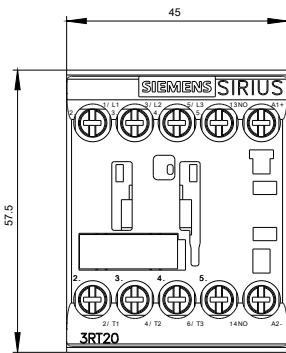

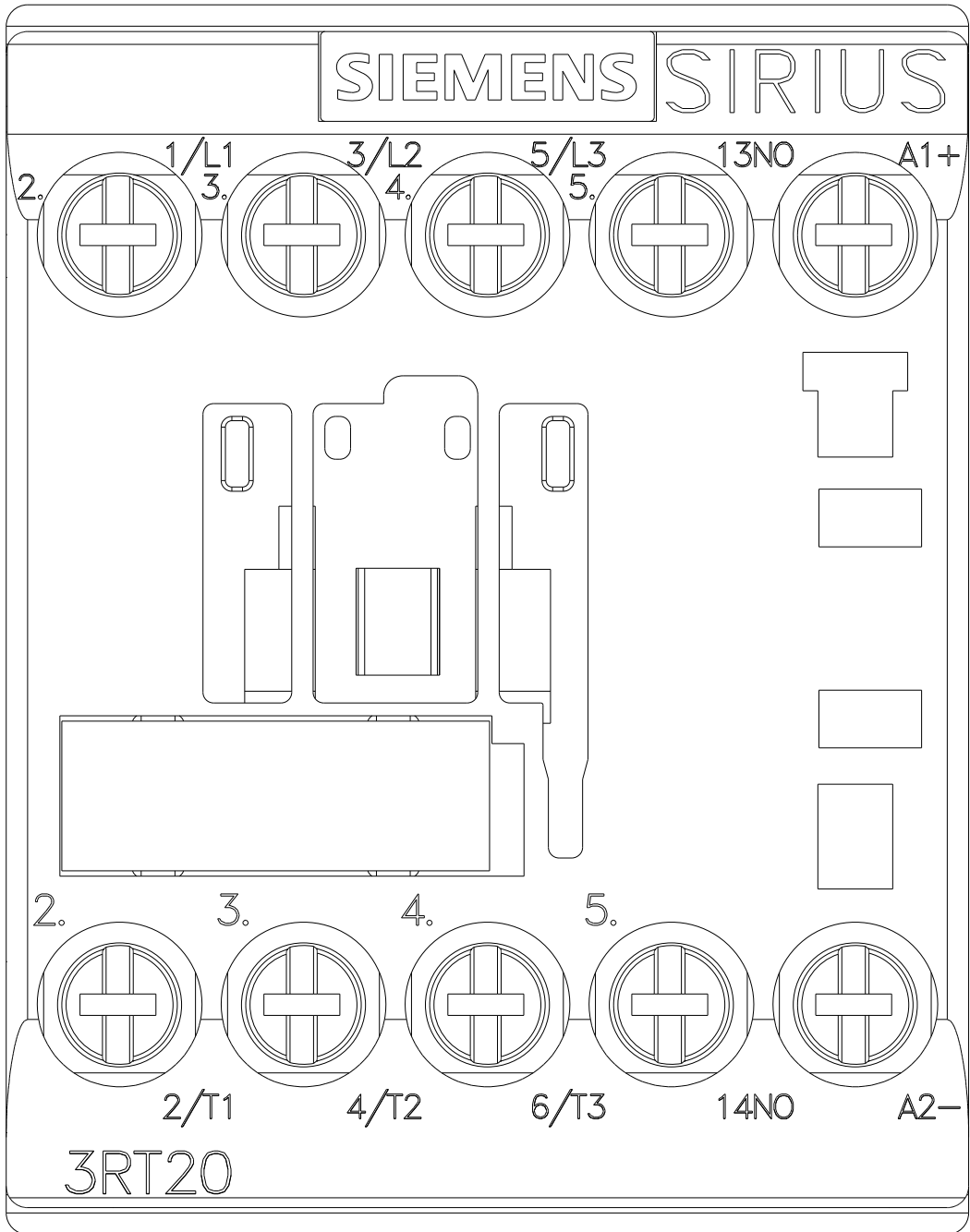

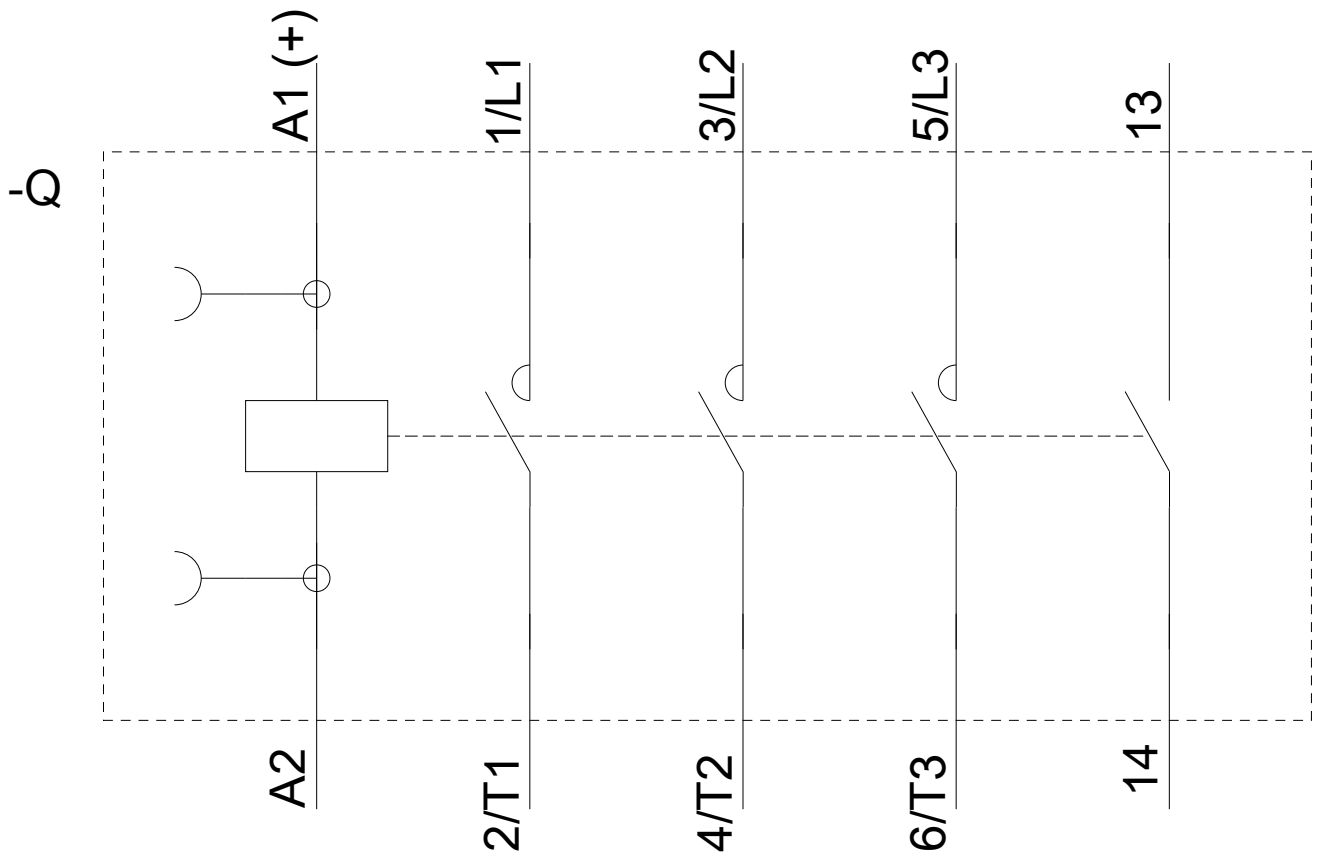

last modified:

10/17/2019